

HYDRO

COLLECTIONS

flair

VERVE
HYDRO
EXPRESS

EXPRESS FIT
SHOWERING

INSTALLERS
CHOICE
REDUCING INSTALLATION TIME

EXPRESS
FIT
QUICK FIT INSTALLATION



See Page
18



See Page
32

SINCE
1952

DESIGNED TO SUIT YOUR **SPACE** AND YOUR **BUDGET**

For over 65 years Flair have been developing shower doors and bathscreens for homeowners. Flair have built an expert knowledge of the industry and a comprehensive understanding of customer needs. The tradition of design excellence continues with the launch of the all new Hydro Express and Verve ranges.

Flawless in design and technically perfect, Hydro Express and Verve offers superb quality with a fast fit system that is a firm favourite with professional installers.



TRUST FLAIR
TRUST HYDRO





EXPRESS FIT - A simple and clever feature in the shower door design, making it quick and easy for the installer to assemble the product.



SPECIFICATION COMPARISON

Choose to upgrade your Hydro Express to a stylish Verve shower door option.



	HYDRO EXPRESS	VERVE	VERVE WETROOM
GLASS THICKNESS	UP TO 6mm TOUGHENED SAFETY GLASS	UP TO 6mm TOUGHENED SAFETY GLASS	8mm TOUGHENED SAFETY GLASS
DOOR HEIGHT	1850mm HEIGHT	1900mm HEIGHT	1900mm HEIGHT
HANDLE TYPE	CHROME ABS HANDLE	SOLID CHROME HANDLE DESIGN	
ROLLER WHEELS	QUICK RELEASE SINGLE WHEEL ROLLER	QUICK RELEASE CHROME DOUBLE WHEEL ROLLER	
GLASS COATING		CLEARVUE GLASS COATING	CLEARVUE GLASS COATING
COVER CAPS		CHROME PLATED COVER CAPS	CHROME PLATED COVER CAPS
ADJUSTMENT SIZE	UP TO 50mm PRODUCT ADJUSTMENT	UP TO 50mm PRODUCT ADJUSTMENT	UP TO 25mm PRODUCT ADJUSTMENT



Our **EXPRESS FIT** design allows the installer to fit Hydro Express & Verve in a quick and easy manner. We have pre-assembled the screws in the horizontal profile, leaving them ready to slot into place. The screw guide rail in the vertical profile makes it easier for the installer to secure the screws into position.

A simple and clever feature in the shower door design, making it quick and easy for the installer to assemble.



STEP 1

Align the horizontal and vertical shower door profiles together.



STEP 2

Slide pre-assembled screws into place on vertical profile, using the guide rails.



STEP 3

Tighten screws into position through the punched access port.

HYDRO WORKS WITH YOU

VERVE

1 Door Quadrant & Offset Quadrant	10
2 Door Quadrant & Offset Quadrant	12
Triple Panel Slider Door	14
Slider Door	16
Corner Entry Door	18
Bi-Fold Door	20
Pivot Door	24
Wetroom	26

HYDRO EXPRESS

2 Door Quadrant & Offset Quadrant	32
Slider Door	34
Corner Entry Door	36
Bi-Fold Door	38
Pivot Door	40

BATHSCREENS

Hydro Bathscreens	42
Verve Bathscreens	44

SLIMLINE SHOWER TRAYS SEE PAGE 50

ANTI-SLIP SHOWER TRAYS SEE PAGE 52

SHOWER TRAYS WITH TILING UPSTAND SEE PAGE 54

WETROOM ACCESSORIES SEE PAGE 56

SHOWER DOOR MEASURING GUIDE SEE PAGE 58

VERVE

Verve is the latest modern Shower Door collection brought to you by Flair Showers. The range features minimalist chrome profiles and a sleek contemporary handle design.

Verve products have 6mm toughened safety glass with Clearvue protective coating to repel unwanted grime and limescale. Each sliding door has quick release double rollers for ease of cleaning. Verve also features an innovative fast fit system that is a firm favourite with installers.

Affordable quality is the essence of the Verve collection.

Verve Matte Black- Anodised Finish

Anodising is an electrochemical process that converts the metal surface to a durable, corrosion resistant, anodic oxide finish. The aluminium oxide finish is not just applied to the surface like a paint or plating, but it is fully integrated with the underlying aluminium substrate so that it cannot chip or peel. For Verve Matte Black, this means a superbly robust product that is designed for the busiest of bathroom environments.

KEY FEATURES

CLEARVUE HYDROPHOBIC COATING RESISTS THE BUILD UP OF GRIME AND LIMESCALE ON THE GLASS SURFACE



WITHOUT TREATMENT



WITH TREATMENT

UP TO 6mm TOUGHENED SAFETY GLASS	 1900mm HEIGHT	UP TO 50mm PRODUCT ADJUSTMENT	 SOLID CHROME HANDLE DESIGN	 QUICK RELEASE CHROME DOUBLE WHEEL ROLLERS	 30mm WALL PROFILE EXTENSION AVAILABLE
 POSITIVE MAGNETIC CLOSE ACTION	 CLEARVUE GLASS COATING	 CHROME PLATED COVER CAPS	 REVERSIBLE FOR LEFT OR RIGHT HANDED INSTALLATION	 20 YEAR GUARANTEE	

INSTALLERS CHOICE
REDUCING INSTALLATION TIME

EXPRESS FIT
QUICK FIT INSTALLATION

VERVE

1 DOOR QUADRANT & 1 DOOR OFFSET QUADRANT

VERVE - 1 DOOR QUADRANT

DESCRIPTION	ADJUSTMENT SIZE		ACCESS	CODE - SILVER	CODE - BLACK
	MIN	MAX			
1 Door Quadrant 800mm	770mm	795mm	490mm	VOCQ80SC	–
1 Door Quadrant 900mm	870mm	895mm	490mm	VOCQ90SC	VOCQ90BC
1 Door Quadrant 1000mm	970mm	995mm	490mm	VOCQ100SC	–

VERVE - 1 DOOR OFFSET QUADRANT

DESCRIPTION	ADJUSTMENT SIZE		ACCESS	CODE - SILVER	CODE - BLACK
	MIN	MAX			
Offset Quadrant 800 x 900mm	770-795mm	870-895mm	490mm	VOCQ80X90SC	–
Offset Quadrant 800 x 1000mm	770-795mm	970-995mm	490mm	VOCQ80X100SC	–
Offset Quadrant 900 x 1000mm	870-895mm	970-995mm	490mm	VOCQ90X100SC	–
Offset Quadrant 800 x 1200mm	770-795mm	1170-1195mm	490mm	VOCQ80X120SC	VOCQ80X120BC
Offset Quadrant 900 x 1200mm	870-895mm	1170-1195mm	490mm	VOCQ90X120SC	VOCQ90X120BC



RIGHT HANDED SILVER
OFFSET QUADRANT TRAY INSTALLATION



LEFT HANDED MATTE BLACK
OFFSET QUADRANT TRAY INSTALLATION



VERVE 1 DOOR

OFFSET QUADRANT



RIGHT HANDED MATTE BLACK
QUADRANT TRAY INSTALLATION



VERVE

1 DOOR QUADRANT

6mm
TOUGHENED
SAFETY GLASS

1900mm
HEIGHT

25mm
PRODUCT
ADJUSTMENT

SOLID CHROME
HANDLE DESIGN

QUICK RELEASE
CHROME DOUBLE
WHEEL ROLLERS

CLEARVUE
GLASS
COATING

CHROME PLATED
COVER CAPS

REVERSIBLE FOR
LEFT OR RIGHT
HANDED
INSTALLATION

*All Flair Quadrant and Offset Quadrant trays have a 550mm radius.

VERVE

2 DOOR QUADRANT



- 6mm**
TOUGHENED SAFETY GLASS
- 1900mm**
HEIGHT
- 25mm**
PRODUCT ADJUSTMENT
- SOLID CHROME HANDLE DESIGN
- QUICK RELEASE CHROME DOUBLE WHEEL ROLLERS
- CLEARVUE GLASS COATING
- CHROME PLATED COVER CAPS

*All Flair Quadrant and Offset Quadrant trays have a 550mm radius.

VERVE 2 DOOR QUADRANT & 2 DOOR OFFSET QUADRANT

VERVE - 2 DOOR QUADRANT

DESCRIPTION	ADJUSTMENT SIZE		ACCESS	CODE - SILVER
	MIN	MAX		
2 Door Quadrant 800mm	770mm	795mm	390mm	VCQ80SC
2 Door Quadrant 900mm	870mm	895mm	540mm	VCQ90SC

VERVE - 2 DOOR OFFSET QUADRANT

DESCRIPTION	ADJUSTMENT SIZE		ACCESS	CODE - SILVER
	MIN	MAX		
Offset Quadrant 800 x 1000mm	770-795mm	970-995mm	470mm	VCQ80X100SC
Offset Quadrant 800 x 1200mm	770-795mm	1170-1195mm	470mm	VCQ80X120SC
Offset Quadrant 900 x 1100mm	875-895mm	1070-1095mm	540mm	VCQ90X110SC
Offset Quadrant 900 x 1200mm	870-895mm	1170-1195mm	540mm	VCQ90X120SC

AVAILABLE AUTUMN 2021



VERVE 2 DOOR
OFFSET QUADRANT



VERVE

TRIPLE PANEL SLIDER

VERVE - SLIDER DOOR

DESCRIPTION	ADJUSTMENT SIZE		ACCESS	CODE - SILVER
	MIN	MAX		
Triple Panel Slider Door 900mm	850mm	900mm	437mm	V3SA90SC
Triple Panel Slider Door 1000mm	950mm	1000mm	504mm	V3SA100SC
Triple Panel Slider Door 1100mm	1050mm	1100mm	570mm	V3SA110SC
Triple Panel Slider Door 1200mm	1150mm	1200mm	637mm	V3SA120SC

VERVE - SIDE PANELS

DESCRIPTION	ADJUSTMENT SIZE		ACCESS	CODE - SILVER
	MIN	MAX		
Side Panel 700mm	670mm	695mm	-	VSP70SC
Side Panel 760mm	730mm	755mm	-	VSP76SC
Side Panel 800mm	770mm	795mm	-	VSP80SC
Side Panel 900mm	870mm	895mm	-	VSP90SC
Side Panel 1000mm	970mm	995mm	-	VSP100SC

*30mm compensating bar included with every Verve Side Panel from June 2021.

Please note, when using a side panel, the maximum door adjustment is reduced by 25mm.

VERVE - PROFILE EXTENSION

DESCRIPTION	CODE - SILVER
Verve 30mm Compensating Bar	VCB30SC



TRIPLE PANEL SLIDER DOOR WITH SIDE PANEL

VERVE
TRIPLE PANEL SLIDER



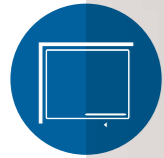

SLIDER DOOR MATTE BLACK

VERVE SLIDER DOOR

VERVE - SLIDER DOOR

DESCRIPTION	ADJUSTMENT SIZE		ACCESS	CODE - SILVER	CODE - BLACK
	MIN	MAX			
Slider Door 1000mm	950mm	1000mm	380mm	VSA100SC	-
Slider Door 1100mm	1050mm	1100mm	430mm	VSA110SC	VSA110BC
Slider Door 1200mm	1150mm	1200mm	480mm	VSA120SC	VSA120BC
Slider Door 1300mm	1250mm	1300mm	530mm	VSA130SC	VSA130BC
Slider Door 1400mm	1350mm	1400mm	580mm	VSA140SC	VSA140BC
Slider Door 1500mm	1450mm	1500mm	580mm	VSA150SC	-
Slider Door 1600mm	1550mm	1600mm	580mm	VSA160SC	VSA160BC
Slider Door 1700mm	1650mm	1700mm	580mm	VSA170SC	VSA170BC
Slider Door 1800mm	1750mm	1800mm	580mm	VSA180SC	-

VERVE - SIDE PANELS

DESCRIPTION	ADJUSTMENT SIZE		ACCESS	CODE - SILVER	CODE - BLACK
	MIN	MAX			
Side Panel 700mm	670mm	695mm	-	VSP70SC	VSP70BC
Side Panel 760mm	730mm	755mm	-	VSP76SC	-
Side Panel 800mm	770mm	795mm	-	VSP80SC	VSP80BC
Side Panel 900mm	870mm	895mm	-	VSP90SC	VSP90BC
Side Panel 1000mm	970mm	995mm	-	VSP100SC	VSP100BC

*30mm compensating bar included with every Verve Side Panel from June 2021.

Please note, when using a side panel, the maximum door adjustment is reduced by 25mm.

VERVE - PROFILE EXTENSION

DESCRIPTION	CODE - SILVER	CODE - BLACK
Verve 30mm Compensating Bar	VCB30SC	VCB30BC



SLIDER DOOR WITH SIDE PANEL MATTE BLACK



SLIDER DOOR SILVER



SLIDER DOOR WITH SIDE PANEL SILVER

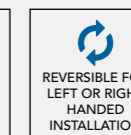
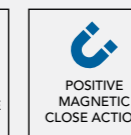
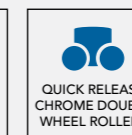
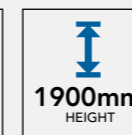

VERVE CORNER ENTRY

VERVE - CORNER ENTRY

DESCRIPTION	ADJUSTMENT SIZE		ACCESS	CODE - SILVER
	MIN	MAX		
Corner Entry 700mm	670mm	695mm	345mm	VCE70SSC
Corner Entry 760mm	730mm	755mm	385mm	VCE76SSC
Corner Entry 800mm	770mm	795mm	415mm	VCE80SSC
Corner Entry 900mm	870mm	895mm	485mm	VCE90SSC
Corner Entry 1000mm	970mm	995mm	555mm	VCE100SSC
Corner Entry 1200mm	1170mm	1195mm	555mm	VCE120SSC



Note: Verve Corner entry is a two box product, code on both boxes are the same.

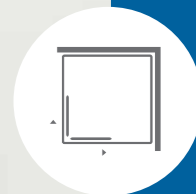
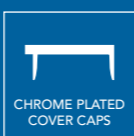

VERVE
CORNER ENTRY

VERVE

BI-FOLD DOOR

VERVE - BI-FOLD DOOR

DESCRIPTION	ADJUSTMENT SIZE		ACCESS	CODE - SILVER	CODE - BLACK
	MIN	MAX			
Bi-Fold Door 700mm	650mm	700mm	413mm	VBF70SC	–
Bi-Fold Door 760mm	710mm	760mm	473mm	VBF76SC	–
Bi-Fold Door 800mm	750mm	800mm	513mm	VBF80SC	VBF80BC
Bi-Fold Door 900mm	850mm	900mm	613mm	VBF90SC	VBF90BC
Bi-Fold Door 1000mm	950mm	1000mm	713mm	VBF100SC	VBF100BC

VERVE - SIDE PANELS

DESCRIPTION	ADJUSTMENT SIZE		ACCESS	CODE - SILVER	CODE - BLACK
	MIN	MAX			
Side Panel 700mm	670mm	695mm	-	VSP70SC	VSP70BC
Side Panel 760mm	730mm	755mm	-	VSP76SC	–
Side Panel 800mm	770mm	795mm	-	VSP80SC	VSP80BC
Side Panel 900mm	870mm	895mm	-	VSP90SC	VSP90BC
Side Panel 1000mm	970mm	995mm	-	VSP100SC	VSP100BC

*30mm compensating bar included with every Verve Side Panel from June 2021.

Please note, when using a side panel, the maximum door adjustment is reduced by 25mm.

VERVE - INLINE PANELS

DESCRIPTION	CODE - SILVER	CODE - BLACK
Inline Panel 200mm	VIL20SC	–
Inline Panel 300mm	VIL30SC	–
Inline Panel 400mm	VIL40SC	–
Inline Panel 500mm	VIL50SC	–



VERVE BI-FOLD DOOR IN ALCOVE

VERVE - PROFILE EXTENSION

DESCRIPTION	CODE - SILVER	CODE - BLACK
Verve 30mm Compensating Bar	VCB30SC	VCB30BC



VERVE BI-FOLD DOOR WITH FRAMELESS SIDE PANEL

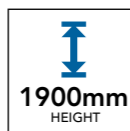

VERVE BI-FOLD DOOR MATTE BLACK IN ALCOVE



VERVE
BI-FOLD DOOR

VERVE
PIVOT DOOR
AND
INLINE PANEL



VERVE
PIVOT DOOR AND INLINE PANEL

**INSTALLERS
CHOICE**
REDUCING INSTALLATION TIME

**EXPRESS
FIT**
QUICK FIT INSTALLATION

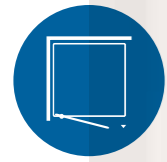

VERVE PIVOT DOOR



VERVE PIVOT DOOR
MATTE BLACK IN ALCOVE

**EXPRESS
FIT**
QUICK FIT INSTALLATION

**INSTALLERS
CHOICE**
REDUCING INSTALLATION TIME

VERVE PIVOT DOOR

VERVE - PIVOT DOOR

DESCRIPTION	ADJUSTMENT SIZE		ACCESS	CODE - SILVER	CODE - BLACK
	MIN	MAX			
Pivot Door 700mm	650mm	700mm	410mm	VPD70SC	–
Pivot Door 760mm	710mm	760mm	470mm	VPD76SC	–
Pivot Door 800mm	750mm	800mm	510mm	VPD80SC	VPD80BC
Pivot Door 900mm	850mm	900mm	610mm	VPD90SC	VPD90BC
Pivot Door 1000mm	950mm	1000mm	710mm	VPD100SC	VPD100BC

VERVE - SIDE PANELS

DESCRIPTION	ADJUSTMENT SIZE		ACCESS	CODE - SILVER	CODE - BLACK
	MIN	MAX			
Side Panel 700mm	670mm	695mm	–	VSP70SC	VSP70BC
Side Panel 760mm	730mm	755mm	–	VSP76SC	–
Side Panel 800mm	770mm	795mm	–	VSP80SC	VSP80BC
Side Panel 900mm	870mm	895mm	–	VSP90SC	VSP90BC
Side Panel 1000mm	970mm	995mm	–	VSP100SC	VSP100BC

*30mm compensating bar included with every Verve Side Panel from June 2021.

Please note, when using a side panel, the maximum door adjustment is reduced by 25mm.

VERVE - INLINE PANELS

DESCRIPTION	CODE - SILVER	CODE - BLACK
Inline Panel 200mm	VIL20SC	–
Inline Panel 300mm	VIL30SC	–
Inline Panel 400mm	VIL40SC	–
Inline Panel 500mm	VIL50SC	–

VERVE - PROFILE EXTENSION

DESCRIPTION	CODE - SILVER	CODE - BLACK
Verve 30mm Compensating Bar	VCB30SC	VCB30BC



VERVE PIVOT DOOR SILVER IN ALCOVE



VERVE PIVOT DOOR SILVER WITH FRAMELESS SIDE PANEL

<p>6mm TOUGHENED SAFETY GLASS</p>	<p>1900mm HEIGHT</p>	<p>50mm PRODUCT ADJUSTMENT</p>	<p>REVERSIBLE FOR LEFT OR RIGHT HANDED INSTALLATION</p>
<p>SOLID CHROME HANDLE DESIGN</p>	<p>QUALITY ENGINEERED HINGE</p>	<p>POSITIVE MAGNETIC CLOSE ACTION</p>	



VERVE WETROOM SCREENS

Choose a Verve wetroom for a luxurious walk-in shower experience. These versatile screens are suitable for shower tray or wetroom floor application.

Verve wetroom panels are constructed from 8mm toughened safety glass and offer superb quality at an affordable price-tag.

<p>8mm TOUGHENED SAFETY GLASS</p>	<p>1900mm HEIGHT</p>	<p>CLEARVUE GLASS COATING</p>
<p>15mm PRODUCT ADJUSTMENT</p>	<p>1m CHROME STABILISING BAR INCLUDED</p>	<p>SHOWER TRAY OR WETROOM FLOOR APPLICATION</p>

Please Note;
Rotating panel
Sold Separately.

VERVE - POLISHED CHROME FINISH - WETROOMS

DESCRIPTION	ADJUSTMENT SIZE		CODE - SILVER
	MIN	MAX	
Verve 700mm Wetroom With Support Bar - Bright Silver	675mm	690mm	VWR70SC NEW
Verve 800mm Wetroom With Support Bar - Bright Silver	775mm	790mm	VWR80SC NEW
Verve 900mm Wetroom With Support Bar - Bright Silver	875mm	890mm	VWR90SC
Verve 1000mm Wetroom With Support Bar - Bright Silver	975mm	990mm	VWR100SC
Verve 1200mm Wetroom With Support Bar - Bright Silver	1175mm	1190mm	VWR120SC

VERVE - POLISHED CHROME FINISH - ROTATING RETURN PANEL

DESCRIPTION	CODE - SILVER
Verve 300mm Rotating Return Panel - Bright Silver	VRP30SC

VERVE - T-PIECE STABILISING BAR

DESCRIPTION	CODE - SILVER
Verve T-Piece - Bright Silver	S-VWRTS

VERVE WETROOM SCREENS



VERVE - NEW MATTE BLACK WETROOM PROFILE KIT

DESCRIPTION	ADJUSTMENT SIZE		CODE - BLACK
	MIN	MAX	
Verve Matte Black Wetroom Kit	875mm	890mm	VWRBLACKKIT



VERVE - MATTE BLACK T-PIECE STABILISING BAR

DESCRIPTION	CODE - BLACK
Verve - Matte Black T-Piece	S-VVRTBLK

*This matte black profile kit will suit Verve wetroom sizes 700mm, 800mm, 900mm, 1000mm & 1200mm.

** Not suitable for installation with return panel.



HYDRO

EXPRESS

The all new Hydro express is an exciting remodel of Hydro - a tried and trusted brand brought to you by Flair Showers. Hydro's new design is crisp and contemporary with sleek modern handles and minimalist chrome profiles.

Each door is 1850mm high and features 5/6mm toughened safety glass. Quick release rollers ensure easy cleaning while magnetic seals provide a watertight close.

This innovative range also boasts an express fit mechanism that is a firm favourite with installers.

Hydro Express - Designed to suit your space and budget.

KEY FEATURES

UP TO 6mm TOUGHENED SAFETY GLASS	1850mm HEIGHT	UP TO 50mm PRODUCT ADJUSTMENT	30mm WALL PROFILE EXTENSION AVAILABLE	
CHROME PLATED ABS HANDLES	QUICK RELEASE SINGLE WHEEL ROLLER	POSITIVE MAGNETIC CLOSE ACTION	REVERSIBLE FOR LEFT OR RIGHT HANDED INSTALLATION	10 YEAR GUARANTEE

**INSTALLERS
CHOICE**
REDUCING INSTALLATION TIME

**EXPRESS
FIT**
QUICK FIT INSTALLATION

HYDRO EXPRESS

2 DOOR QUADRANT & OFFSET QUADRANT

HYDRO EXPRESS - 2 DOOR QUADRANT

DESCRIPTION	ADJUSTMENT SIZE		ACCESS	CODE - SILVER
	MIN	MAX		
2 Door Quadrant 800mm	770mm	795mm	395mm	HYCQ80SC
2 Door Quadrant 900mm	870mm	895mm	545mm	HYCQ90SC

HYDRO EXPRESS - OFFSET QUADRANT

DESCRIPTION	ADJUSTMENT SIZE		ACCESS	CODE - SILVER
	MIN	MAX		
Offset Quadrant 800x1000mm	770-795mm	970-995mm	475mm	HYCQ80X100SC
Offset Quadrant 800x1200mm	770-795mm	1170-1195mm	475mm	HYCQ80X120SC
Offset Quadrant 900x1200mm	870-895mm	1170-1195mm	545mm	HYCQ90X120SC



CONTEMPORARY HANDLE DESIGN

RIGHT HANDED OFFSET QUADRANT TRAY INSTALLATION



HYDRO EXPRESS OFFSET QUADRANT

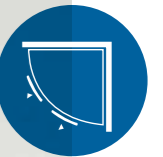

HYDRO EXPRESS 2 DOOR QUADRANT

5mm
TOUGHENED SAFETY GLASS

1850mm
HEIGHT

25mm
PRODUCT ADJUSTMENT

|||
CHROME PLATED ABS HANDLES

⚙
QUICK RELEASE SINGLE WHEEL ROLLERS

⤵
POSITIVE MAGNETIC CLOSE ACTION

↻
REVERSIBLE FOR LEFT OR RIGHT HANDED INSTALLATION

HYDRO EXPRESS SLIDER DOOR



HYDRO EXPRESS SLIDING DOOR
WITH FRAMELESS SIDE PANEL



QUICK RELEASE
BOTTOM ROLLERS



HYDRO EXPRESS - SLIDER DOOR

DESCRIPTION	ADJUSTMENT SIZE		ACCESS	CODE - SILVER
	MIN	MAX		
Slider Door 1000mm	950mm	1000mm	380mm	HYSA100SC
Slider Door 1100mm	1050mm	1100mm	430mm	HYSA110SC
Slider Door 1200mm	1150mm	1200mm	480mm	HYSA120SC

HYDRO EXPRESS - SIDE PANELS

DESCRIPTION	ADJUSTMENT SIZE		ACCESS	CODE - SILVER
	MIN	MAX		
Side Panel 700mm	670mm	695mm	-	HYSP70SC
Side Panel 760mm	730mm	755mm	-	HYSP76SC
Side Panel 800mm	770mm	795mm	-	HYSP80SC
Side Panel 900mm	870mm	895mm	-	HYSP90SC

Please note, when using a side panel, the maximum door adjustment is reduced by 25mm.

DESCRIPTION	CODE - SILVER
Hydro Express Compensating Bar 30mm	HYCB30SC

5E+6E

TOUGHENED
SAFETY GLASS

1850mm

HEIGHT

50E

DOOR
ADJUSTMENT

||

CHROME PLATED
HANDLES

⚙️

QUICK RELEASE
SINGLE WHEEL
ROLLER

🔗

POSITIVE
MAGNETIC
CLOSE ACTION

↻

REVERSIBLE FOR
LEFT OR RIGHT
HANDED
INSTALLATION



HYDRO EXPRESS SLIDER DOOR

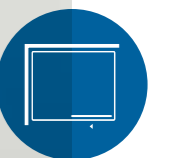

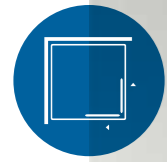

HYDRO EXPRESS CORNER ENTRY DOOR



HYDRO EXPRESS CORNER ENTRY DOOR



HYDRO EXPRESS - CORNER ENTRY

DESCRIPTION	ADJUSTMENT SIZE		ACCESS	CODE - SILVER
	MIN	MAX		
Corner Entry 760mm	730mm	755mm	390mm	HYCE76SC
Corner Entry 800mm	770mm	795mm	420mm	HYCE80SC
Corner Entry 900mm	870mm	895mm	490mm	HYCE90SC

CONTEMPORARY
HANDLE DESIGN



QUICK RELEASE
BOTTOM ROLLERS

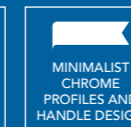

HYDRO EXPRESS BI-FOLD DOORS

HYDRO EXPRESS - BI-FOLD DOOR

DESCRIPTION	ADJUSTMENT SIZE		ACCESS	CODE - SILVER
	MIN	MAX		
Bi-Fold Door 760mm	710mm	760mm	473mm	HYBF76SC
Bi-Fold Door 800mm	750mm	800mm	513mm	HYBF80SC
Bi-Fold Door 900mm	850mm	900mm	613mm	HYBF90SC
Bi-Fold Door 1000mm	950mm	1000mm	713mm	HYBF100SC
Bi-Fold Door 1100mm	1050mm	1100mm	813mm	HYBF110SC

HYDRO EXPRESS - SIDE PANELS

DESCRIPTION	ADJUSTMENT SIZE		ACCESS	CODE - SILVER
	MIN	MAX		
Side Panel 700mm	670mm	695mm	-	HYSP70SC
Side Panel 760mm	730mm	755mm	-	HYSP76SC
Side Panel 800mm	770mm	795mm	-	HYSP80SC
Side Panel 900mm	870mm	895mm	-	HYSP90SC

Please note, when using a side panel, the maximum door adjustment is reduced by 25mm.

DESCRIPTION	CODE - SILVER
30mm Wall Profile Extension	HYCB30SC



BI-FOLD DOOR
WITH SIDE PANEL



BI-FOLD DOORS
HYDRO EXPRESS

**INSTALLERS
CHOICE**
REDUCING INSTALLATION TIME

**EXPRESS
FIT**
QUICK FIT INSTALLATION

5mm
TOUGHENED
SAFETY GLASS

1850mm
HEIGHT

50mm
DOOR
ADJUSTMENT

**CHROME PLATED
HANDLES**

**POSITIVE
MAGNETIC
CLOSE ACTION**

**REVERSIBLE FOR
LEFT OR RIGHT
HANDED
INSTALLATION**

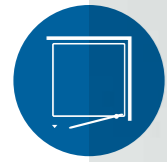

HYDRO EXPRESS PIVOT DOOR



HYDRO EXPRESS PIVOT DOOR

HYDRO EXPRESS - PIVOT DOOR

DESCRIPTION	ADJUSTMENT SIZE		ACCESS	CODE - SILVER
	MIN	MAX		
Pivot Door 760mm	710mm	760mm	480mm	HYPD76SC
Pivot Door 800mm	750mm	800mm	520mm	HYPD80SC
Pivot Door 900mm	850mm	900mm	620mm	HYPD90SC

HYDRO EXPRESS - SIDE PANELS

DESCRIPTION	ADJUSTMENT SIZE		ACCESS	CODE - SILVER
	MIN	MAX		
Side Panel 700mm	670mm	695mm	-	HYSP70SC
Side Panel 760mm	730mm	755mm	-	HYSP76SC
Side Panel 800mm	770mm	795mm	-	HYSP80SC
Side Panel 900mm	870mm	895mm	-	HYSP90SC

Please note, when using a side panel, the maximum door adjustment is reduced by 25mm.

DESCRIPTION	CODE - SILVER
Hydro Express Compensating Bar 30mm	HYCB30SC



HYDRO EXPRESS PIVOT DOOR WITH SIDE PANEL



QUALITY PIVOT HINGE DESIGN

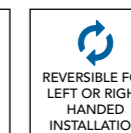
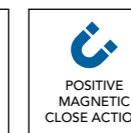
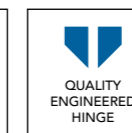
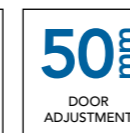
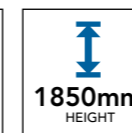

HYDRO

4 & 5 PANEL BATHSCREENS

IMPORTANT NOTE:

- These bath screens are a water deflector and splash proof only.
- It is advised that all bath screens are fitted to the inside edge of the bath to ensure maximum effectiveness.



4 PANEL BATH SCREEN



5 PANEL BATH SCREEN

HYDRO - BATHSCREEN

DESCRIPTION	SIZE	COLOUR	CODE
4 Panel Bath Screen	1400 x 850mm	Silver	PBSG4SC
5 Panel Bath Screen	1400 x 1100mm	Silver	PBSG5SC
5 Panel Bath Screen	1400 x 1100mm	White	PBSG5WC

BATH PANELS

High gloss acrylic white bath panels.



BATH PANELS

PRODUCT DESCRIPTION	SIZE	COLOUR	CODE
Front Bath Panel	533 x 1700mm	White	BP5FWH
End Bath Panel	533 x 711mm	White	BP5EWH

VERVE

CURVED BATHSCREENS

IMPORTANT NOTE:

- These bath screens are a water deflector and splash proof only.
- It is advised that all bath screens are fitted to the inside edge of the bath to ensure maximum effectiveness.



6mm CURVED 2 PANEL BATHSCREEN
BOTH PANELS ROTATING - VBS5SC



6mm CURVED 2 PANEL BATH SCREEN -
1 FIXED & 1 ROTATING PANEL - VBS7SC



6mm SAIL BATHSCREEN
WITH TOWEL RAIL- VBS12SC



6mm CURVED ROTATING
BATHSCREEN - VBS1SC



6mm CURVED ROTATING
BATHSCREEN WITH TOWEL RAIL - VBS3SC

VERVE - CURVED BATHSCREENS

DESCRIPTION	HEIGHT	WIDTH	CODE
6mm Curved 2 Panel Bathscreen Both Panels Rotating	1500mm	900mm	VBS5SC
6mm Curved 2 Panel Bathscreen - 1 Fixed & 1 Rotating Panel	1500mm	900mm	VBS7SC
6mm Sail Bathscreen With Towel Rail	1500mm	800mm	VBS12SC
6mm Curved Rotating Bathscreen	1400mm	800mm	VBS1SC
6mm Curved Rotating Bathscreen With Towel Rail	1500mm	800mm	VBS3SC
Verve Bathscreen L-Shape Silver Profile with Cover Strip - 1500mm (2 Profiles Per Pack)			S-VLPSC



IMPORTANT NOTE:

- These bath screens are a water deflector and splash proof only.
- It is advised that all bath screens are fitted to the inside edge of the bath to ensure maximum effectiveness.



6mm 2 PANEL SCREEN - BOTH PANELS ROTATING - SQUARE EDGE - VBS6SC



6mm 2 PANEL BATH SCREEN - 1 FIXED & 1 ROTATING PANEL - VBS8SC



6mm ROTATING BATHSCREEN - SQUARE EDGE WITH TOWEL RAIL - VBS4SC

VERVE - SQUARE BATHSCREENS

DESCRIPTION	HEIGHT	WIDTH	CODE
6mm 2 Panel Screen - Both Panels Rotating - Square Edge	1500mm	900mm	VBS6SC
6mm 2 Panel Bath Screen - 1 Fixed & 1 Rotating Panel	1500mm	900mm	VBS8SC
6mm Rotating Bathscreen - Square Edge with Towel Rail	1500mm	800mm	VBS4SC



VERVE

SQUARE BATHSCREENS



6mm ROTATING BATHSCREEN - SQUARE EDGE - VBS2SC



6mm FIXED BATHSCREEN WITH CHROME ANGLED SUPPORT BAR - VBS10SC



6mm BATHSCREEN DEFLECTOR - 300mm WIDE - FBSG30SG



CURTAIN RAIL BATHSCREEN 300mm - VBS9SC

VERVE - SQUARE BATHSCREENS

DESCRIPTION	HEIGHT	WIDTH	CODE
6mm Rotating Bathscreen - Square Edge	1400mm	800mm	VBS2SC
6mm Fixed Bathscreen with Chrome Angled Support Bar	1400mm	850mm	VBS10SC
6mm Bathscreen Deflector - 300mm Wide	1430mm	300mm	FBSG30SG
Curtain Rail Bathscreen 300mm	1400mm	850mm	VBS9SC



SLIMLINE SHOWER TRAYS

Extensive selection of shower tray shapes and sizes to complement your bathroom to accompany the Hydro Express and Verve Ranges.

- Strong and rigid construction
- Manufactured to British Standard BS6340/5
- Tough high gloss ABS acrylic capped surface finish
- Easy-to-clean and maintain

SHOWER TRAY INSTALLATION
All shower trays must be installed as per instructions supplied. Please note: Silicone sealants, foams, mastics, installation compound adhesive etc. must not be used as a substitute for cement. Ensure shower tray is installed 100% level and water test to ensure it is draining correctly. Fitting of Shower Tray is acceptance of quality.

40mm HEIGHT	SLEEK LOW PROFILE DESIGN
90mm HIGH FLOW WASTE	EASY CLEAN FILTER TRAP
SUITABLE FOR CONVERSION TO EASY PLUMB TRAY	SUITABLE FOR CONVERSION TO UPSTAND TRAY

SLIMLINE RECTANGLE

PRODUCT DESCRIPTION	CODE
800 x 700mm Slimline Rectangle Tray	TSL8070R
900 x 700mm Slimline Rectangle Tray	TSL9070R
900 x 760mm Slimline Rectangle Tray	TSL9076R
900 x 800mm Slimline Rectangle Tray	TSL9080R
1000 x 700mm Slimline Rectangle Tray	TSL10070R
1000 x 760mm Slimline Rectangle Tray	TSL10076R
1000 x 800mm Slimline Rectangle Tray	TSL10080R
1000 x 900mm Slimline Rectangle Tray	TSL10090R
1100 x 700mm Slimline Rectangle Tray	TSL11070R
1100 x 760mm Slimline Rectangle Tray	TSL11076R
1100 x 800mm Slimline Rectangle Tray	TSL11080R
1100 x 900mm Slimline Rectangle Tray	TSL11090R
1200 x 700mm Slimline Rectangle Tray	TSL12070R
1200 x 760mm Slimline Rectangle Tray	TSL12076R
1200 x 800mm Slimline Rectangle Tray	TSL12080R
1200 x 900mm Slimline Rectangle Tray	TSL12090R
1300 x 800mm Slimline Rectangle Tray	TSL13080R
1300 x 900mm Slimline Rectangle Tray	TSL13090R
1400 x 700mm Slimline Rectangle Tray	TSL14070R
1400 x 800mm Slimline Rectangle Tray	TSL14080R
1400 x 900mm Slimline Rectangle Tray	TSL14090R
1500 x 700mm Slimline Rectangle Tray	TSL15070R
1500 x 760mm Slimline Rectangle Tray	TSL15076R
1500 x 800mm Slimline Rectangle Tray	TSL15080R
1500 x 900mm Slimline Rectangle Tray	TSL15090R
1600 x 700mm Slimline Rectangle Tray	TSL16070R
1600 x 800mm Slimline Rectangle Tray	TSL16080R
1600 x 900mm Slimline Rectangle Tray	TSL16090R
1700 x 700mm Slimline Rectangle Tray	TSL17070R
1700 x 750mm Slimline Rectangle Tray	TSL17075R
1700 x 800mm Slimline Rectangle Tray	TSL17080R
1700 x 900mm Slimline Rectangle Tray	TSL17090R
1800 x 800mm Slimline Rectangle Tray	TSL18080R
1800 x 900mm Slimline Rectangle Tray	TSL18090R
2000 x 900mm Slimline Rectangle Tray	TSL20090R



NOTE: It is normal for a small amount of localized water to be retained on a shower tray surface after use. This should be wiped dry to prevent any build up of residue.

SLIMLINE SQUARE

PRODUCT DESCRIPTION	CODE
700 x 700mm Slimline Square Tray	TSL70S
760 x 760mm Slimline Square Tray	TSL76S
800 x 800mm Slimline Square Tray	TSL80S
900 x 900mm Slimline Square Tray	TSL90S
1000 x 1000mm Slimline Square Tray	TSL100S
1200 x 1200mm Slimline Square Tray	TSL120S

SLIMLINE QUADRANT

PRODUCT DESCRIPTION	CODE
800 x 800mm Slimline Quadrant Tray	TSL80Q
900 x 900mm Slimline Quadrant Tray	TSL90Q
1000 x 1000mm Slimline Quadrant Tray	TSL100Q

OFFSET QUADRANT

PRODUCT DESCRIPTION	CODE
900 x 800mm Offset Quadrant Tray - Left	TSL9080LOQ
900 x 800mm Offset Quadrant Tray - Right	TSL9080ROQ
1000 x 800mm Offset Quadrant Tray - Left	TSL10080LOQ
1000 x 800mm Offset Quadrant Tray - Right	TSL10080ROQ
1000 x 900mm Offset Quadrant Tray - Left	TSL10090LOQ
1000 x 900mm Offset Quadrant Tray - Right	TSL10090ROQ
1100 x 800mm Offset Quadrant Tray - Left	TSL11080LOQ
1100 x 800mm Offset Quadrant Tray - Right	TSL11080ROQ
1100 x 900mm Offset Quadrant Tray - Left	TSL11090LOQ
1100 x 900mm Offset Quadrant Tray - Right	TSL11090ROQ
1200 x 800mm Offset Quadrant Tray - Left	TSL12080LOQ
1200 x 800mm Offset Quadrant Tray - Right	TSL12080ROQ
1200 x 900mm Offset Quadrant Tray - Left	TSL12090LOQ
1200 x 900mm Offset Quadrant Tray - Right	TSL12090ROQ



SLIMLINE RECTANGLE TRAY INCLUDING SHOWER WASTE



SLIMLINE SQUARE TRAY INCLUDING SHOWER WASTE



SLIMLINE OFFSET TRAY INCLUDING SHOWER WASTE



SLIMLINE OFFSET QUADRANT TRAY INCLUDING SHOWER WASTE (right hand illustrated)

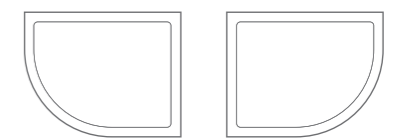

OFFSET QUADRANT LEFT HAND

OFFSET QUADRANT RIGHT HAND

ANTI-SLIP SHOWER TRAYS

NOTE: It is normal for a small amount of localized water to be retained on a shower tray surface after use. This should be wiped dry to prevent any build up of residue.

ANTI-SLIP SLIMLINE RECTANGLE

PRODUCT DESCRIPTION	CODE
Anti-Slip Slimline Rectangle Tray 1000 x 800mm	ASTSL10080R
Anti-Slip Slimline Rectangle Tray 1000 x 900mm	ASTSL10090R
Anti-Slip Slimline Rectangle Tray 1100 x 800mm	ASTSL11080R
Anti-Slip Slimline Rectangle Tray 1100 x 900mm	ASTSL11090R
Anti-Slip Slimline Rectangle Tray 1200 x 700mm	ASTSL12070R
Anti-Slip Slimline Rectangle Tray 1200 x 760mm	ASTSL12076R
Anti-Slip Slimline Rectangle Tray 1200 x 800mm	ASTSL12080R
Anti-Slip Slimline Rectangle Tray 1200 x 900mm	ASTSL12090R
Anti-Slip Slimline Rectangle Tray 1400 x 700mm	ASTSL14070R
Anti-Slip Slimline Rectangle Tray 1400 x 800mm	ASTSL14080R
Anti-Slip Slimline Rectangle Tray 1400 x 900mm	ASTSL14090R
Anti-Slip Slimline Rectangle Tray 1500 x 700mm	ASTSL15070R
Anti-Slip Slimline Rectangle Tray 1500 x 800mm	ASTSL15080R
Anti-Slip Slimline Rectangle Tray 1500 x 900mm	ASTSL15090R
Anti-Slip Slimline Rectangle Tray 1600 x 700mm	ASTSL16070R
Anti-Slip Slimline Rectangle Tray 1600 x 800mm	ASTSL16080R
Anti-Slip Slimline Rectangle Tray 1600 x 900mm	ASTSL16090R
Anti-Slip Slimline Rectangle Tray 1700 x 700mm	ASTSL17070R
Anti-Slip Slimline Rectangle Tray 1700 x 800mm	ASTSL17080R
Anti-Slip Slimline Rectangle Tray 1700 x 900mm	ASTSL17090R

- Anti-slip coating for extra safety in the showering space
- Pendulum slip tested, in accordance with British Standard BS7976:2
- Classified as low slip potential



SHOWER TRAY INSTALLATION
All shower trays must be installed as per instructions supplied. Please note: Silicone sealants, foams, mastics, installation compound adhesive etc. must not be used as a substitute for cement. Ensure shower tray is installed 100% level and water test to ensure it is draining correctly. Fitting of Shower Tray is acceptance of quality.

- 40mm HEIGHT
- ANTI SLIP SURFACE
- 90mm HIGH FLOW WASTE
- EASY CLEAN FILTER TRAP
- SUITABLE FOR CONVERSION TO EASY PLUMB TRAY
- SUITABLE FOR CONVERSION TO UPSTAND TRAY
- SLEEK LOW PROFILE DESIGN

ANTI-SLIP SLIMLINE SQUARE

PRODUCT DESCRIPTION	CODE
Anti-Slip Slimline Square Tray 800mm	ASTSL80S
Anti-Slip Slimline Square Tray 900mm	ASTSL90S
Anti-Slip Slimline Square Tray 1000mm	ASTSL100S

ANTI-SLIP SLIMLINE QUADRANT

PRODUCT DESCRIPTION	CODE
Anti-Slip Slimline Quadrant Tray 800mm	ASTSL80Q
Anti-Slip Slimline Quadrant Tray 900mm	ASTSL90Q
Anti-Slip Slimline Quadrant Tray 1000mm	ASTSL100Q

ANTI-SLIP OFFSET QUADRANT

PRODUCT DESCRIPTION	CODE
Anti-Slip Slimline Offset Quadrant Tray 1000 x 800mm - Left	ASTSL10080LOQ
Anti-Slip Slimline Offset Quadrant Tray 1000 x 800mm - Right	ASTSL10080ROQ
Anti-Slip Slimline Offset Quadrant Tray 1000 x 900mm - Left	ASTSL10090LOQ
Anti-Slip Slimline Offset Quadrant Tray 1000 x 900mm - Right	ASTSL10090ROQ
Anti-Slip Slimline Offset Quadrant Tray 1200 x 800mm - Left	ASTSL12080LOQ
Anti-Slip Slimline Offset Quadrant Tray 1200 x 800mm - Right	ASTSL12080ROQ
Anti-Slip Slimline Offset Quadrant Tray 1200 x 900mm - Left	ASTSL12090LOQ
Anti-Slip Slimline Offset Quadrant Tray 1200 x 900mm - Right	ASTSL12090ROQ

CORNER SHOWER TRAY WASTES

CORNER SHOWER TRAY WASTES

PRODUCT DESCRIPTION	CODE
800 x 800mm Slimline Quadrant Tray - Corner Waste	CTSL80Q
900 x 900mm Slimline Quadrant Tray - Corner Waste	CTSL90Q
800 x 800mm Slimline Square Tray - Corner Waste	CTSL80S
900 x 900mm Slimline Square Tray - Corner Waste	CTSL90S
900 x 800mm Slimline Rectangle Tray - Corner Waste	CTSL9080R
1000 x 800mm Slimline Rectangle Tray - Corner Waste	CTSL10080R
1200 x 800mm Slimline Rectangle Tray - Corner Waste	CTSL12080R
1200 x 900mm Slimline Rectangle Tray - Corner Waste	CTSL12090R



RECTANGLE TRAY CORNER WASTE



SQUARE TRAY CORNER WASTE



900mm QUADRANT TRAY CORNER WASTE



800mm QUADRANT TRAY CORNER WASTE

SLIMLINE SHOWER TRAYS WITH TILING UPSTAND

SLIMLINE SQUARE

PRODUCT DESCRIPTION	CODE
Slimline Tray 760mm Square Tray Upstand With Waste	TSL76SU
Slimline Tray 800mm Square Tray Upstand With Waste	TSL80SU
Slimline Tray 900mm Square Tray Upstand With Waste	TSL90SU



SLIMLINE SQUARE TRAY INCLUDING SHOWER WASTE AND UPSTAND

SLIMLINE RECTANGLE

PRODUCT DESCRIPTION	CODE
Slimline Tray 900 x 760mm Rectangle Tray Upstand With Waste	TSL9076RU
Slimline Tray 1000 x 760mm Rectangle Tray Upstand With Waste	TSL10076RU
Slimline Tray 1000 x 800mm Rectangle Tray Upstand With Waste	TSL10080RU
Slimline Tray 1200 x 760mm Rectangle Tray Upstand With Waste	TSL12076RU
Slimline Tray 1200 x 800mm Rectangle Tray Upstand With Waste	TSL12080RU
Slimline Tray 1200 x 900mm Rectangle Tray Upstand With Waste	TSL12090RU
Slimline Tray 1400 x 800mm Rectangle Tray Upstand With Waste	TSL14080RU
Slimline Tray 1400 x 900mm Rectangle Tray Upstand With Waste	TSL14090RU
Slimline Tray 1700 x 750mm Rectangle Tray Upstand With Waste	TSL17075RU



SLIMLINE RECTANGLE TRAY INCLUDING SHOWER WASTE AND UPSTAND



SLIMLINE QUADRANT TRAY INCLUDING SHOWER WASTE AND UPSTAND

SLIMLINE QUADRANT

PRODUCT DESCRIPTION	CODE
Slimline Tray 800mm Quadrant Upstand With Waste	TSL80QU
Slimline Tray 900mm Quadrant Upstand With Waste	TSL90QU

SLIMLINE TRAY WITH EASY PLUMB KIT

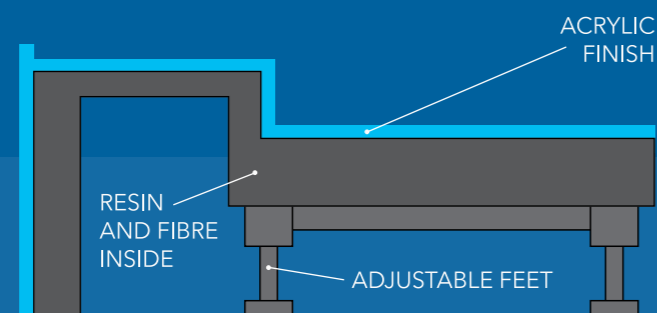

EASY PLUMB KIT SUITS ALL SLIMLINE SHOWER TRAYS

Slimline easy plumb shower kits have adjustable legs to comply with building regulations to assist in installation and for maintenance of waste outlets if required after building settlement.

The slimline easy plumb kit provides this access without compromising on style in the bathroom.

An easy plumb tray can be made by using any of the Flair slimline trays and a kit. This will increase the height of the tray by 95mm.

Accessories are not to scale - for visual representation only.



DESCRIPTION	WEIGHT	CODE
Easy Plumb Riser Kit For All Square Trays & Rectangle Trays (Suitable for maximum tray size of 1200mm)	2kg	WD3
Easy Plumb Riser Kit For All Quadrant Trays (Suitable for maximum tray size of 1200 x 900mm)	3kg	WD4
Easy Plumb Riser Kit For All Square Trays & Rectangle Trays (Suitable for maximum tray size of 2000mm)	2kg	WD5
Viva Shower Waste	1kg	TSLWASTE

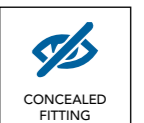
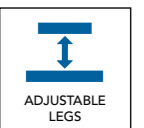
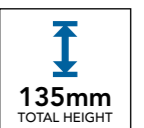

PROSEAL WATERPROOF BARRIER SEAL

Flexible up-stand seal installed onto shower trays, baths and worktops eliminating the risk of water leakage.

PROSEAL

PRODUCT DESCRIPTION	CODE
ProSeal 2 metre Roll	PROS2.0M
ProSeal 2.5 metre Roll	PROS2.5M
ProSeal 3 metre Roll	PROS3.0M
ProSeal 3.5 metre Roll	PROS3.5M
ProSeal 4 metre Roll	PROS4.0M
ProSeal 10 metre Roll	PROS10.0M
ProSeal 20 metre Roll	PROS20.0M

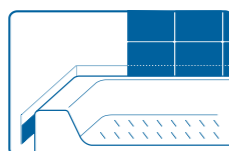
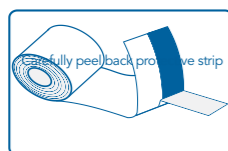

SEE PAGE
14 - 15
FOR DETAILS



TRIPLE PANEL SLIDER
DOOR WITH SIDE PANEL

SHOWER TRAY SHAPES

FIND YOUR PERFECT FIT



SQUARE



RECTANGLE



QUADRANT



OFFSET QUADRANT LEFT HAND



OFFSET QUADRANT RIGHT HAND

SHOWER DOOR STYLES

DESIGNED TO FIT YOUR SPACE



SLIDER DOOR



CORNER ENTRY



OFFSET QUADRANT



PIVOT DOOR



QUADRANT



BIFOLD DOOR

AT A GLANCE METRIC CONVERTER

NOMINAL GUIDE ONLY

METRIC (MM)	FEET (FT)	INCHES (INS)
700	2 ft 3.5	27.5
760	2 ft 6.0	30
800	2 ft 7.5	31.5
900	2 ft 11.4	35.5
1000	3 ft 3.5	39.5
1100	3 ft 7.3	43.3
1200	3 ft 11.2	47.2

SHOWER DOOR MEASURING GUIDE

Note: Your measurements should be taken after tray installation and tiling.
The space left after tiling will determine the shower door size required.

FOR A RECESS

Measurement at low point _____

Measurement at high point _____

* Two measures relevant for uneven walls to ensure shower door caters for adjustment width needed

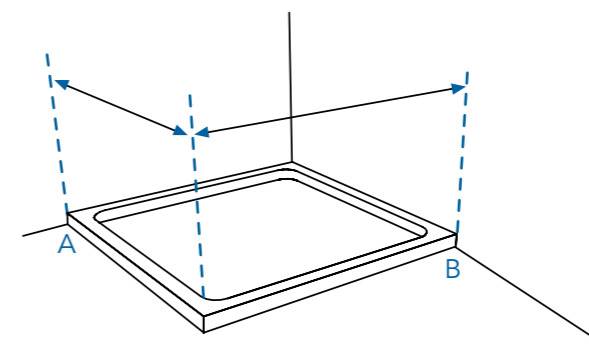
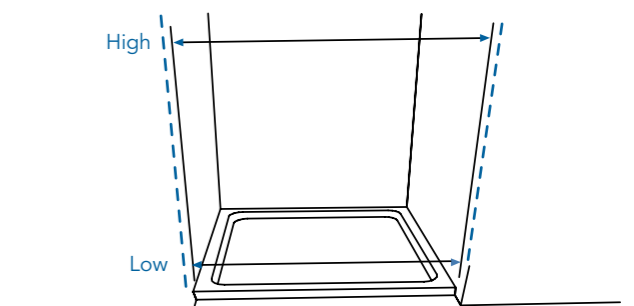

FOR A CORNER

Measure to acute edge of shower tray

Measurement A _____ B _____

FOR A QUADRANT*

Radius Guide	
Distance 'C' (mm)	Radius (mm)
207	500
288	525
249	550

*All Flair Quadrant and Offset Quadrant trays have a 550mm radius.

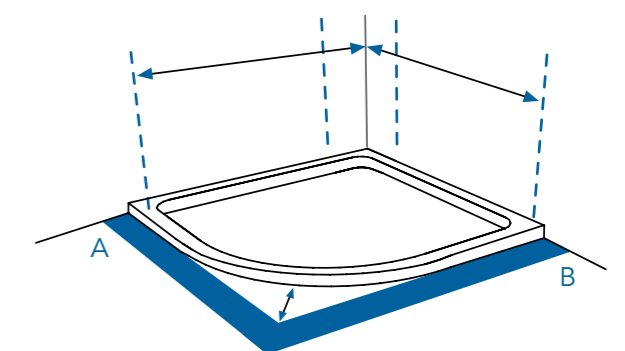

Timbers placed at right angles to determine C

Measurement

A _____ B _____ C _____

QUALITY GUARANTEED

QUALITY GUARANTEED

At Flair we have an unwavering commitment to product quality.

All Flair products are CE approved and manufactured in accordance with ISO 9001:2000 Quality Assurance systems. All glass is toughed safety glass and produced to EN12150. Flair products are performance tested to EN14428, ensuring the highest industry criteria is met.

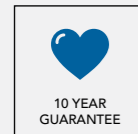

HYDRO shower doors and bath screens are covered by a 10 year guarantee against manufacturer defect.

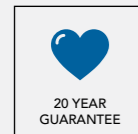

VERVE shower doors, bath screens and wetrooms are covered by a 20 year guarantee against manufacturer defect.

This guarantee is valid on condition that the goods are installed and maintained in accordance with the products fitting instructions and best practices.

Non glass and detachable parts such as rollers, seals etc. are subject to normal wear and tear during usage and are under guarantee for 12 months from time of purchase.

Please complete your product guarantee card included in the components box or register online at flairshowers.com/register.

Note: Proof of purchase is necessary to validate your guarantee so retain purchase receipt for your Flair product.

If a Flair shower enclosure is defective in materials or manufacture, please contact us on 00353 42 966 8000.

CLEARVUE GLASS TREATMENT SYSTEM

VERVE shower doors, wetroom panels and bath screens are supplied with a special glass coating designed to reduce limescale build up and make cleaning the glass easier:

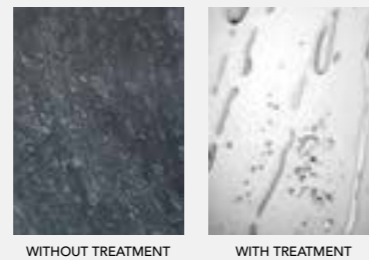

AFTERSALES & SPARE PARTS SERVICE

Flair is 100% committed to customer service excellence.

We carry a full range of spare parts for each product range and have dedicated aftersales specialists to deal with any issues you may have.

If you have any queries, please contact Flair on 00353 42 966 8000.

RETURN POLICY

Flair will not accept return of any product that has been opened.

We do not accept return of any product if the packaging has been damaged.

If the product is unopened and not damaged, we will accept the return of the product but a handling fee of 25% of the invoice price will be charged.

SHOWER DOOR INSTALLATION ADVICE

BEFORE YOU INSTALL YOUR SHOWER ENCLOSURE PLEASE READ ALL INSTRUCTIONS. FAILURE TO DO SO MAY LEAD TO INVALIDATION OF YOUR GUARANTEE.

Flair Showers Ltd will not accept responsibility for any loss or damage, however caused, if the shower enclosure has not been installed as per the instructions.

- The shower tray **MUST** be fitted 100% level. The shower tray must be sealed correctly to prevent any water leakage.
- Glass edges are vulnerable and should be treated with care at all times. Contact with hard surfaces may result in glass breakage if due care is not taken.
- Check walls for electrical cabling or water pipes before drilling.
- Your shower enclosure, bath screen or wetroom must be inspected before installation. Check for all visual defects on the product before installation. Once the enclosure has been installed no claims of damage or defect will be accepted. Fitting of shower enclosure is acceptance of quality.
- The wall plugs supplied with the shower door are for use in solid walls. Timber frame, stud partition walls will require alternative fixings.
- Ensure vertical wall profiles are level and are an equal distance in from the tray.
- Shower Doors, Wetroom Screens, Bath Screens and Side Panels are adjustable between the dimensions stated. All dimensions are approximate.
- Ensure adjustment at wall profiles are equal at both sides and that all screws are fully tightened.
- Ensure hinges are level and securely fitted to the glass.
- Ensure magnets are the right orientation and are attracting rather than repelling.
- The shower enclosure should be sealed on the outside only using silicone sealant.

- Care must be taken during assembly. Flair will not accept responsibility where incorrect assembly results in undue stress being put on any components in this product.
- If there are any manufacturer defects, please call Flair Service Line on +353 42 966 8000.
- Note: If a problem has been caused by incorrect installation, a call-out charge will apply for the Flair technical engineer's time. Subsequent charges will apply "to fix" a problem caused by incorrect installation.

BATH SCREEN INSTALLATION

The bath screen must be installed on a 100% level surface with the bath edge free from obstructions.

Bath screens should not be used on a bath with roll top rim, stepped edge rim or where the bath handle void meets the bath screen seal. This will impact on the performance of the bathscreen and the guarantee will be void. The Bath screen should be fitted to the inside edge of the bath only.

A bath screen acts as a water deflector and is not 100% waterproof. If used appropriately under normal showering conditions and installed to the inside edge of the bath, water will be deflected into the showering area. Bath Screens are not suitable for power showers.

SHOWER TRAY INSTALLATION

All shower trays must be installed as per instructions supplied. Install on a base of fine sand, cement and cement additive. Please note: Silicone sealants, foams, mastics, installation compound adhesive or similar must not be used as a substitute for cement. Ensure shower tray is 100% level and water test to ensure water is draining correctly. If not satisfied at any stage do not proceed with fitting. Fitting of Shower Tray is acceptance of quality.

NOTE: It is normal for a small amount of localised water to be retained on a shower tray surface after use. This should be wiped dry to prevent any build up of residue.

CLEANING GUIDELINES

- Glass: Use a soft cloth and mild detergent, rinse off thoroughly.
- Metallic Surfaces: Use a soft cloth and warm soapy water. Rinse off thoroughly.
- Do not use "Spray & leave" cleaning products on the metal surface as these will cause damage to your product. These include acidic based cleaning products, bleaches, solvents or abrasive pads. Only use detergents, cleaners and limescale removers with a pH of 5-8.
- The constant use of detergents will degrade the finish of the product over time if not thoroughly rinsed off.
- In hard water areas, regular cleaning of your Flair door will help to prevent the build-up of limescale. Stubborn deposits of limescale can be removed with the use of a mild limescale remover.
- Check your shower door for functionality periodically. Ensure that the wheel track is free from any grit/dirt which may have collected over time.

CONDITIONS OF SALE

Unless otherwise stated, all price quotations are subject to acceptance within 30 days of date of issue. Other than in the case of faulty goods / incorrect despatch, Flair will not accept the return of any product.

As part of our continuing policy of product improvement, we reserve the right to amend specifications, colours and prices without prior notice. Images are for illustrative purposes only. The colours and finishes shown in the catalogue are as accurate as possible within the limits of the printing process. The positioning of all shower heads and shower wastes in the brochure is for illustrative purposes only.

*Errors and Omissions Exempt.



DESIGNED
TO SUIT YOUR
SPACE AND
YOUR BUDGET

HYDRO WORKS WITH YOU

VERVE
HYDRO
EXPRESS

EXPRESS FIT
SHOWERING



Flair Showers Ltd.
Rocks Road
Kingscourt
Co Cavan
Ireland

T +353 42 966 8000
E sales@flairshowers.com

FLAIRSHOWERS.COM